

EXPLODED DRAWING A

Model No. NTL15421-INT.2 R0321A

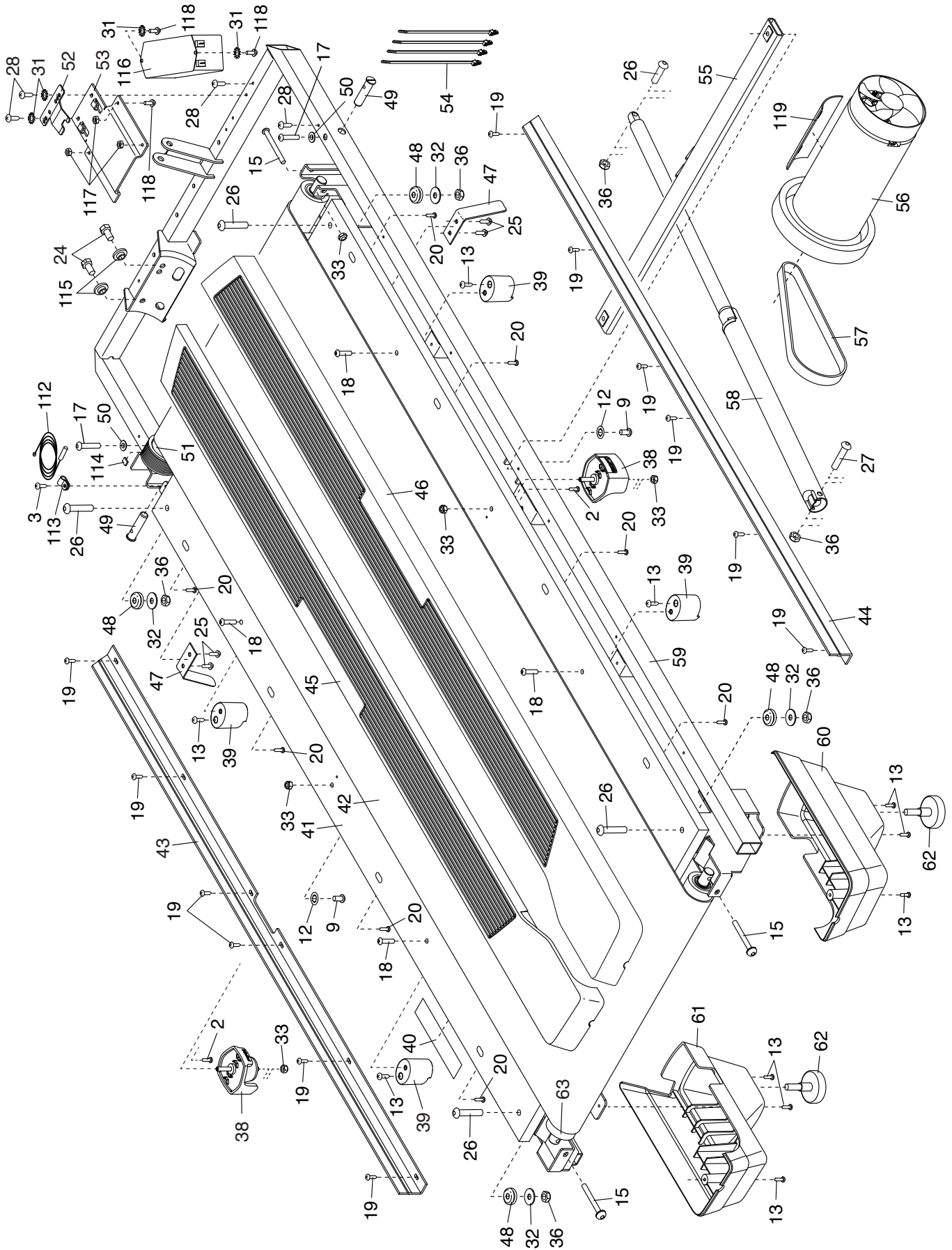

EXPLODED DRAWING B

Model No. NTL15421-INT.2 R0321A

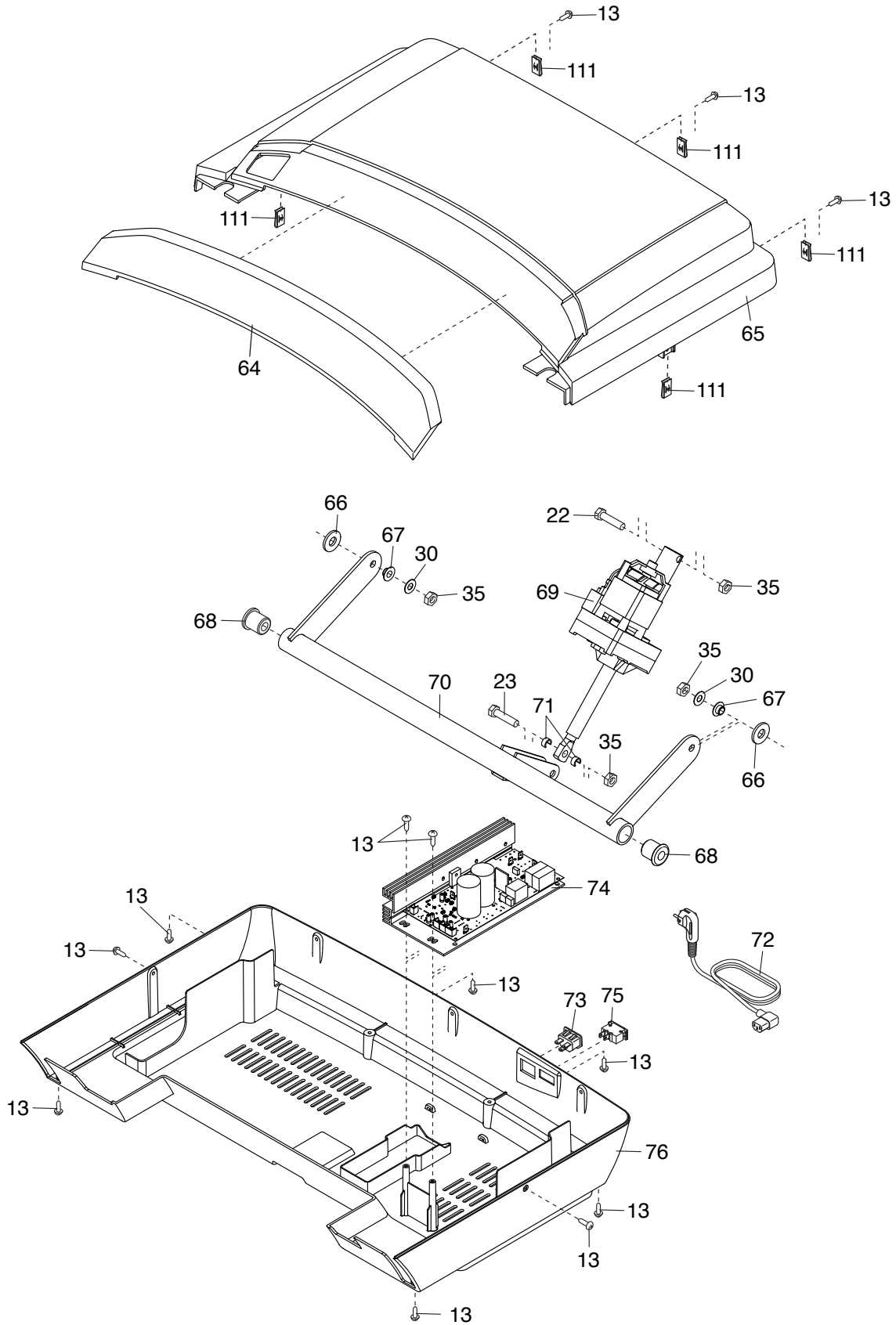

EXPLODED DRAWING C

Model No. NTL15421-INT.2 R0321A

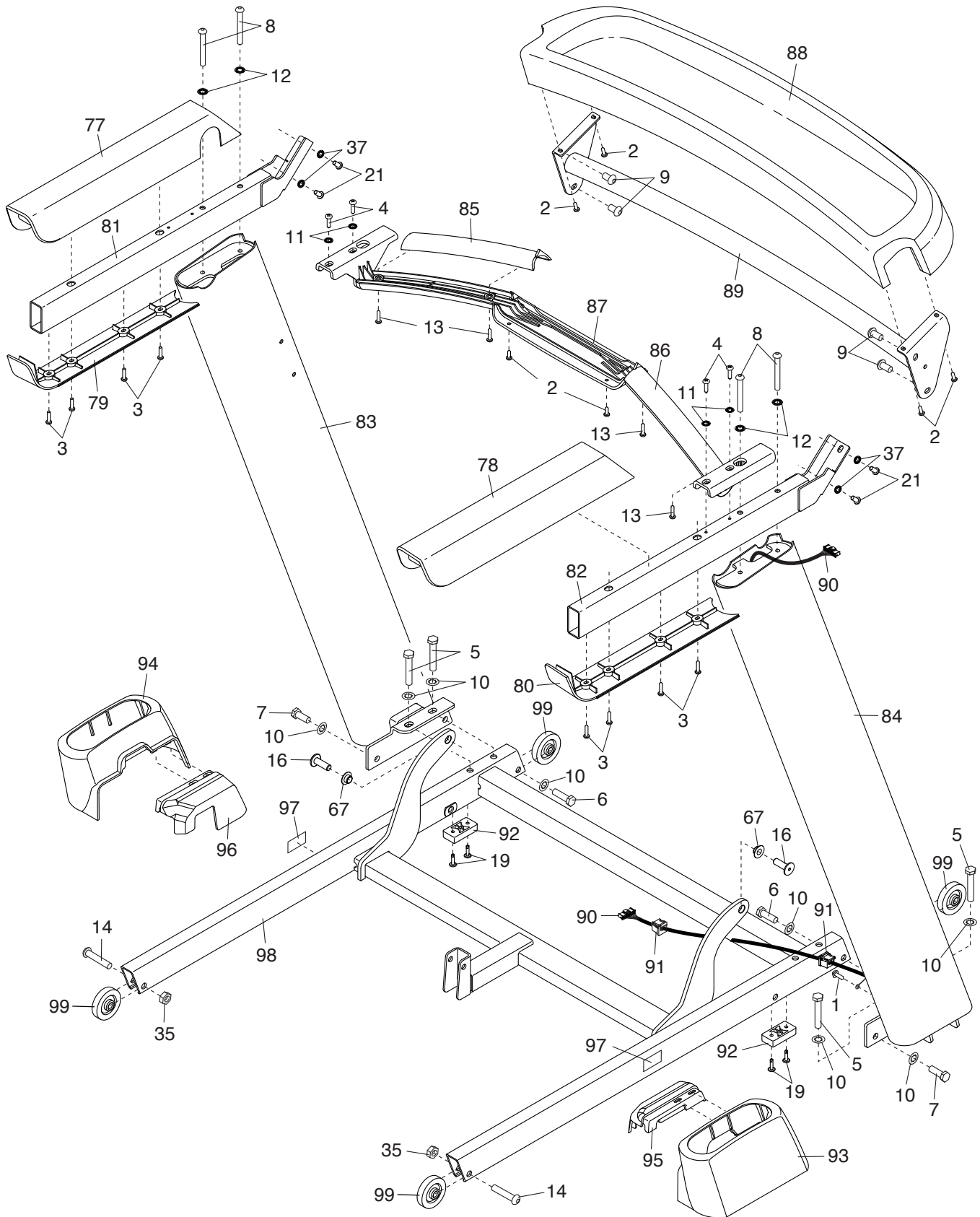

EXPLODED DRAWING D

Model No. NTL15421-INT.2 R0321A

